

NI10U-M12E-VP6X-H1141

Inductive Sensor – With Extended Switching Distance

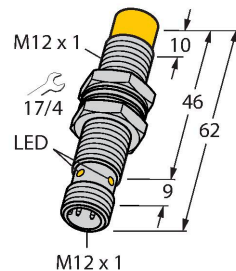

Technical data

Type	NI10U-M12E-VP6X-H1141
ID	100000622
General data	
Rated switching distance	10 mm
Mounting conditions	Non-flush
Secured operating distance	$\leq (0.81 \times S_n)$ mm
Repeat accuracy	$\leq 2\%$ of full scale
Temperature drift	$\leq \pm 10\%$ $\leq \pm 15\%$, $\leq -25\text{ °C}$ v $\geq +70\text{ °C}$
Hysteresis	3...15 %
Electrical data	
Operating voltage U_B	10...30 VDC
Ripple U_{ss}	$\leq 10\%$ U_{Bmax}
DC rated operating current I_o	≤ 200 mA
No-load current	≤ 15 mA
Residual current	≤ 0.1 mA
Isolation test voltage	0.5 kV
Short-circuit protection	yes/Cyclic
Voltage drop at I_o	≤ 1.8 V
Wire break/reverse polarity protection	yes/Complete
Output function	4-wire, Complementary contact, PNP
DC field stability	300 mT
AC field stability	300 mT _{ss}
Switching frequency	1 kHz
Mechanical data	
Design	Threaded barrel, M12 x 1
Dimensions	62 mm

Features

- M12 × 1 threaded barrel
- Long version
- Chrome-plated brass
- Factor 1 for all metals
- Protection class IP68
- Resistant to magnetic fields
- Large switching distance
- Integrated protection against predamping
- Little metal-free spaces
- DC 4-wire, 10...30 VDC
- Changeover contact, PNP output
- M12 x 1 male connector

Wiring diagram

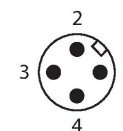
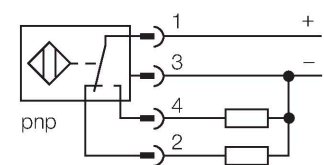

Functional principle

Inductive sensors are designed for wear-free and contactless detection of metal objects. apux+ sensors have significant advantages due to their patented multi-coil system. They excel thanks to their optimum switching distances, maximum flexibility and operational reliability as well as efficient standardization.

Technical data

Housing material	Metal, CuZn, Chrome-plated
Active area material	Plastic, LCP
Max. tightening torque of housing nut	10 Nm
Electrical connection	Connector, M12 × 1
Environmental conditions	
Ambient temperature	-30...+85 °C
Vibration resistance	55 Hz (1 mm)
Shock resistance	30 g (11 ms)
Protection class	IP68
MTTF	874 years acc. to SN 29500 (Ed. 99) 40 °C
Switching state	LED, Yellow

Mounting instructions

Mounting instructions/Description

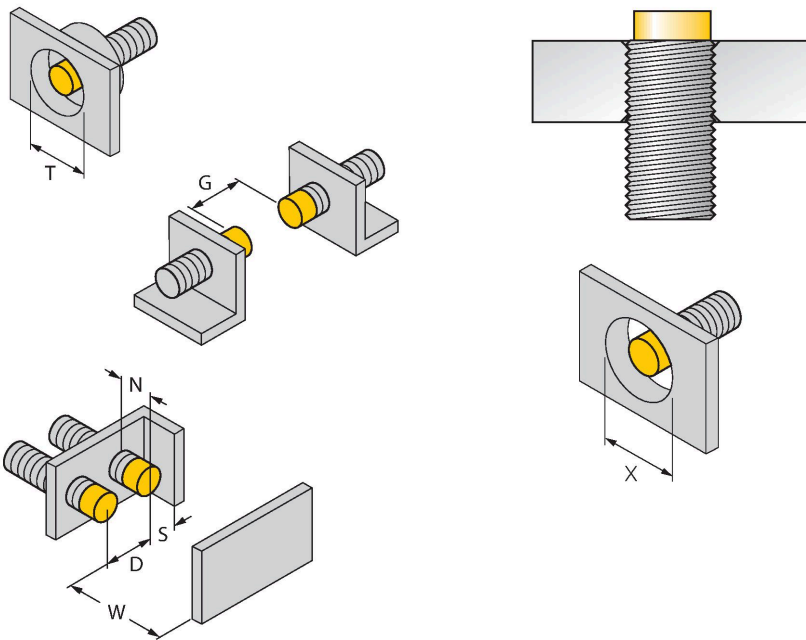

Distance D	48 mm
Distance W	3 x Sn
Distance T	3 x B
Distance S	1.5 x B
Distance G	6 x Sn
Distance N	2 x Sn
Diameter active area B	Ø 12 mm

All non-flush mountable uprox®+ threaded barrel sensors can be screwed to the upper edge of the barrel. In this mounting position, the sensor operates safely with a 20 % reduced switching distance.

When installed in an aperture plate a distance of $X = 50$ mm must be observed.

Accessories

BST-12B

6947212

Mounting clamp for threaded barrel sensors, with dead-stop; material: PA6

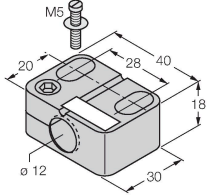

QM-12

6945101

Quick-mount bracket with dead-stop; material: Chrome-plated brass. Male thread M16 × 1. Note: The switching distance of the proximity switches may change when using quick-mount brackets.

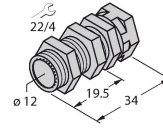

MW12

6945003

Mounting bracket for threaded barrel sensors; material: Stainless steel A2 1.4301 (AISI 304)

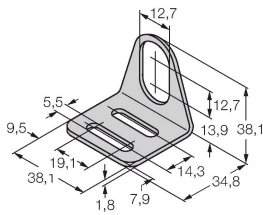

BSS-12

6901321

Mounting clamp for smooth and threaded barrel sensors; material: Polypropylene

