

TN-UHF-Q300-BRA-LNX

UHF Reader

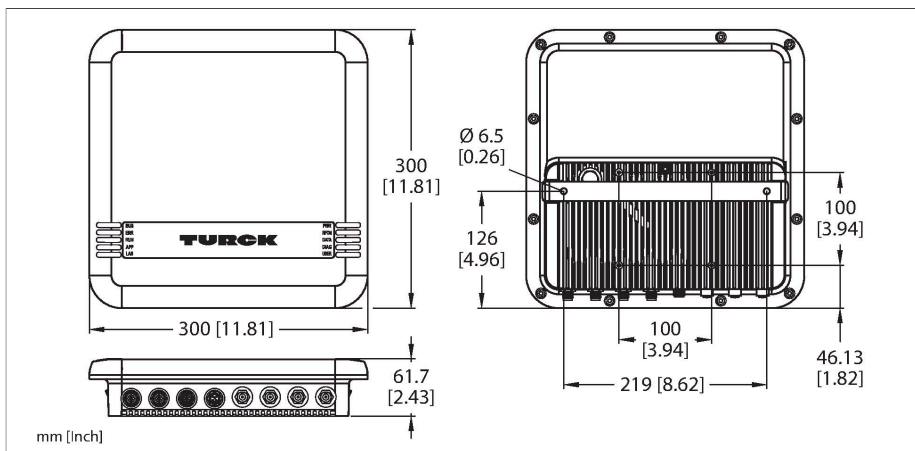

Technical data

Type	TN-UHF-Q300-BRA-LNX
ID	100000917
Electrical data	
Operating voltage	18...30 VDC
DC rated operational current	≤ 3500 mA
PoE standard	IEEE 802.3at (PoE+)
Data transfer	Alternating electromagnetic field
Technology	UHF RFID
Region (UHF)	Brazil (902...907.5 + 915...928 MHz)
Radio communication and protocol standards	ISO 18000-63 EPCglobal Gen 2
Channel spacing	500 kHz
Output power	≤ 36 dBm (EIRP), adjustable
Antenna polarization	circular/linear, adjustable
Antenna HPBW	65°
Output function	Read/Write
Mechanical data	
Mounting conditions	Non-flush
Ambient temperature	-20...+50 °C
Design	Rectangular
Dimensions	300 x 300 x 61.7 mm
Housing material	Aluminium, AL, Silver
Active area material	Glass fiber-reinforced polyamide, PA6-GF30, black
Vibration resistance	55 Hz (1 mm)
Shock resistance	30 g (11 ms)
Protection class	IP67
Electrical connection	RP-TNC
Input impedance	50 Ohm

Features

- TCP/IP
- Freely programmable Ethernet-based read/write head based on Linux
- Programming language C, C++, NodeJS, Python
- Software components: SSH, SFTP, HTTP, IBTP, MTXP, DHCP, SNTP, Node.js 6.9.5 (LTS), Python 3.x
- Implementation of the protocol is required
- 4 RP-TNC connections for passive, external UHF antennas
- 4 digital channels, configurable as PNP inputs and/or 0.5 A outputs
- 10 Mbps/100 Mbps transfer rate
- Integrated web server
- LED displays and diagnostics
- Device only suitable for operation in Brazil (BRA) at 915...928 MHz

Functional principle

The UHF readers form a transmission zone, the size of which may vary depending on the combination of reader and tag used. The achievable distances may be different due to component tolerances, mounting location in the application, ambient conditions and the effect of materials (particularly metal). Testing of the application under real operating conditions is therefore essential, especially with on-the-fly reading and writing!

Technical data

MTTF 49 years acc. to SN 29500 (Ed. 99) 20 °C

System description	
Processor	ARM Cortex A8, 32 Bit, 800 MHz
Memory	512 MB Flash
RAM memory	512 MB DDR3
System data	
Transmission rate Ethernet	10/100 Mbps
Connection technology Ethernet	1 x M12, 4-pin, D-coded
Digital inputs	
Number of channels	4
Connectivity inputs	M12, 5-pin
Input type	PNP
Switching threshold	EN 61131-2 type 3, PNP
Low-level signal voltage	< 5 V
High level signal voltage	> 11 V
Low level signal current	< 1.5 mA
High level signal current	> 2 mA
Type of input diagnostics	Channel diagnostics
Digital outputs	
Number of channels	4
Connectivity outputs	M12, 5-pin
Output type	PNP
Type of output diagnostics	Channel diagnostics
General Information	
Packaging unit	1

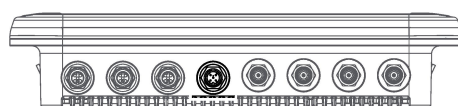

Note
Power cable:
UX18415 RKC 4.4T-0.5-RSM 40/S3520
UX18416 RKC 4.4T-2-RSM 40/S3520
UX14184 RKC 4.4T-3-RSM 40/S3520
UX14185 RKC 4.4T-5-RSM 40/S3520

M12 × 1 Power Supply

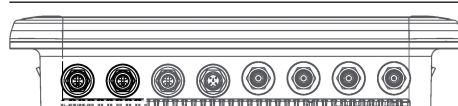
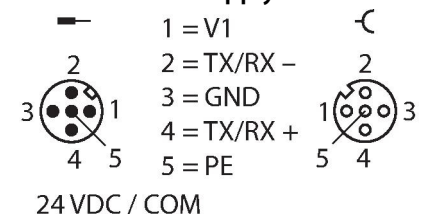

Note
Actuator and sensor cable/PUR connection cable (example):
RKC4.4T-2-RSC4.4T/TXL
ID no. 6625608
Y-piece for DXPs
VBS2-FSM4.4-2FKM4
ID no. 6930560

I/O port M12 × 1

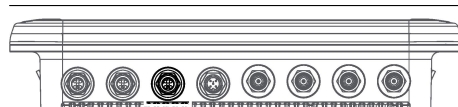
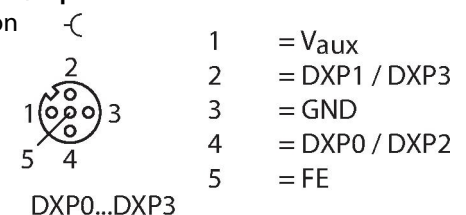

Note
Ethernet cable (example):
RSSD-RJ45S-4416-5M
Ident. no. 6441633

M12 × 1 Ethernet

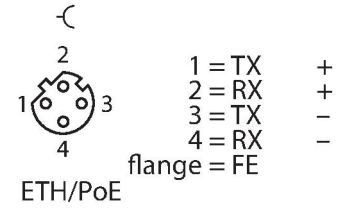

Accessories

Dimension drawing	Type	ID	
	TN-UHF-CBL-HF240-RPTNC-1-SMA	100028191	HF240 coaxial cable, length 1 m
	TN-UHF-CBL-HF240-RPTNC-2-SMA	100028192	HF240 coaxial cable, length 2 m
	TN-UHF-CBL-HF240-RPTNC-4-SMA	100028193	HF240 coaxial cable, length 4 m
	TN-UHF-CBL-HF240-RPTNC-6-SMA	100028194	HF240 coaxial cable, length 6 m
	TN-UHF-CBL-HF240-RPTNC-8-SMA	100028195	HF240 coaxial cable, length 8 m
	TN-UHF-CBL-HF240-RPTNC-10-SMA	100028196	HF240 coaxial cable, length 10 m
	TN-UHF-CBL-HF240-RPTNC-12-SMA	100028197	HF240 coaxial cable, length 12 m

Accessories

Dimension drawing	Type	ID	
	TN-UHF-ANT-Q150-FCC	100028596	Passive UHF RFID antenna with dimensions of 150 × 150 mm
	TN-UHF-ANT-NF-Q150-ETSI-FCC	100028594	Passive UHF RFID near-field antenna with dimensions of 150 × 150 mm
	TN-UHF-ANT-Q280-FCC	100028602	Passive UHF RFID antenna with integrated VESA100 pins and dimensions of 280 × 280 mm

Dimension drawing

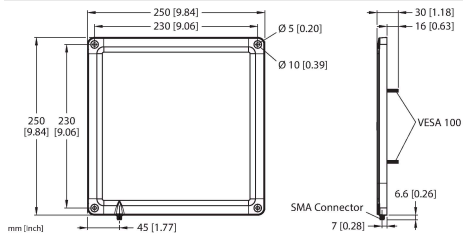

Type

TN-UHF-ANT-Q250-FCC

ID

100028600

Passive UHF RFID antenna with dimensions of 250 × 250 mm